

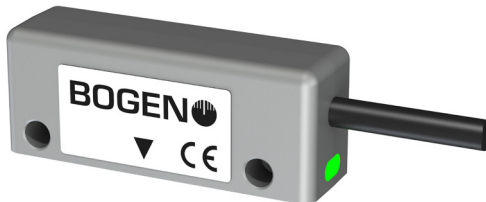

Measuring

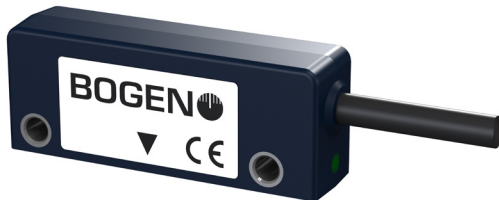

Positioning



IKS9 Incremental Magnetic Encoder

- For linear applications
- For rotary applications
- For scales with or without index

Features

- High accuracy better than 10 μm
- Resolution up to 20 nm
- Movement speed up to 100 m/sec
- Easy adaption to application-specific needs
- Resistant to contamination, vibrations, temperature fluctuations, humidity
- No wear from usage
- Corresponding scales in various lengths and diameters, with various pole pitches, with or without index

Magnetic measuring with the IKS9 accurate - fast - customizable

BOGEN's incremental encoder IKS9 impresses customers in all industrial fields where positions, distances and speed have to be measured. An accuracy better than 10 μm , a movement speed up to 100 m per second, an almost unlimited measuring length and a robust design are the characteristics of this encoder. Several adjustable parameters allow an easy modification of the IKS9 to application-specific needs by the customer himself. The protection class IP67 allows the implementation even in harsh environment. In combination with a corresponding scale - linear, rotary-radial or rotary-axial - a highly accurate, reliable and fast collection of measuring data is possible.

Features

Resolution	0.020 to 1250 μm , depending on the pole pitch
Max. Movement Speed	up to 100 m/s, depending on the pole pitch, resolution and Max Output Freq. (maximum movement speed of P 0.5 is 25 m/s; P 1 is 50 m/s; P 2 is 100 m/s; P 2.54 is 125 m/s and P5 250 m/s)
Energy consumption (without Load)	<65 mA (UB = 5 V)
Operating temperature	-20 to +70 $^{\circ}\text{C}$
Storage temperature	-20 to +80 $^{\circ}\text{C}$
Protection class	IP67
LED ⁽¹⁾	green LED = set up ok red LED = LED Error Mode see order codes on Page 6
Adjustable parameters	Resolution, maximum output frequency, counting direction and interface (with optional programming device and the appropriate software)
Weight	Weight IKS9 (plastic case) ~60g (L2 T1 C4 standard quality cabel with length 2 m; connector D-SUB 15) Weight IKS9.1 (metal case) ~75g (L2 T1 C4 standard quality cabel with length 2 m; connector D-SUB 15)
Maximum tightening torque for M3 screws ^(*)	0.4 Nm (3.5 lbf in)

⁽¹⁾For additional information please see LED Mode on Page 6

^(*)lbf in = poundforce inch

Resolution and Speed

Default Values at Output Frequency F = 1000 kHz

Pole Pitch P [mm]	Resolution R [μm]	Max. Movement Speed Vmax [m/s]
0.5	0.25	1
1	0.5	2
2	1	4
2.54	1.27	5.08
5	2.5	10

Sensing Head Variants

Pole pitch	0.5 mm; 1 mm; 2 mm; 2.54mm; 5 mm
Reference	Reference chip for 2nd track (except for 0.5 mm pole pitch) or periodically from the pole pitch
Supply voltage	V5 = 5 V \pm 5 % V24 = 7 - 32 V
Interface (without load)	D1 = RS422 (0 to 5 V) D2 = Push-Pull HTL (0 to supply voltage) D3 = Push-Pull TTL (0 to 5 V)
Cable length of sensing head	Standard 2 m, optional variable length from 10 cm up to 6 m
Connector	plug according to order code, other options on request

Output Circuit

RS422

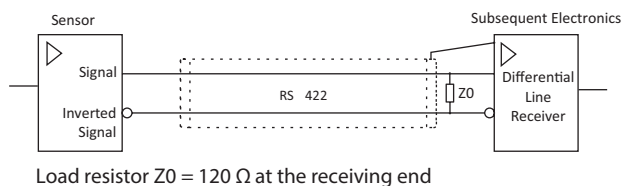

Push-Pull (HTL, TTL)

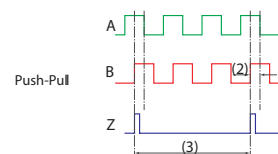
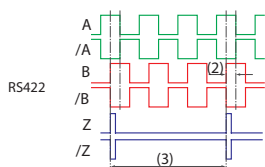
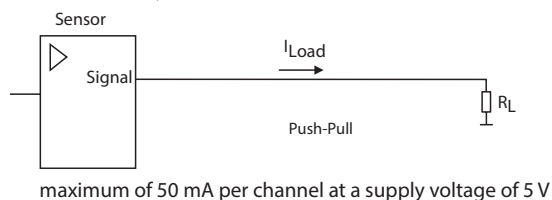

Output Signals

Signals	A, /A, B, /B, Z, /Z
Signal error indicator	High impedance on all output signals (A, /A, B, /B, Z, /Z)

- (2) Phase shift A and B 90° \pm 10° electrical
- (3) Signal period depending on the reference track pattern or as a periodic reference depending on the pole pitch
- Z Length default is 50 counts

To avoid EMI please connect housing to protective earthing!

Further Selection (Ordering Parameters)

Pole Pitch <i>P</i> [mm]					Resolution <i>R</i> [μm]	Resolution <i>Rdpi</i> [dpi]	Maximum Output Frequency per channel <i>F</i> [kHz]					
0.5	1	2	2.54	5			3500	1750	1000	500	100	60
(0.1 inch)							Max. Movement Speed <i>Vmax</i> [m/s]					
				x	1250	20.32	>100	>100	>100	>100	>100	>100
		x		x	500	50.8	>100	>100	>100	>100	>100	>100
	x	x		x	200	127	>100	>100	>100	>100	80	48
x	x	x		x	100	254	>100	>100	>100	>100	40	24
		x			80	317.5	>100	>100	>100	>100	32	19.2
x	x	x		x	62.5	406.4	>100	>100	>100	>100	25	15
x	x	x		x	50	508	>100	>100	>100	>100	20	12
	x	x		x	40	635	>100	>100	>100	80	16	9.6
x	x	x		x	25	1016	>100	>100	>100	50	10	6
x	x	x	x	x	20	1270	>100	>100	80	40	8	4.8
x	x	x		x	12.5	2032	>100	87.5	50	25	5	3
x	x	x	x	x	10	2540	>100	70	40	20	4	2.4
x	x	x	x	x	5	5080	70	35	20	10	2	1.2
x	x	x	x	x	4	6350	56	28	16	8	1.6	0.96
x	x	x	x	x	2.5	10160	35	17.5	10	5	1	0.6
x	x	x	x	x	2	12700	28	14	8	4	0.8	0.48
x	x	x	x	x	1	25400	14	7	4	2	0.4	0.24
x	x	x	x	x	0.5	50800	7	3.5	2	1	0.2	0.12
x	x	x	x	x	0.25	101600	3.5	1.75	1	0.5	0.1	0.06
x	x	x	x	x	0.125	203200	1.75	0.875	0.5	0.25	0.05	0.03
x	x	x	x		0.05	508000	0.7	0.35	0.2	0.1	0.02	0.012
x	x				0.02	1270000	0.28	0.14	0.08	0.04	0.008	0.0048

Table 1: Maximum output frequency and speed as a function of pole pitch and resolution

Definition:

Resolution *R* (resolution is after four-edge analyses)

Pole pitch *P* (available 0.5; 1; 2; 2.54 and 5 mm)

Resolution factor *Rf* (resolution factor available from 4 to 65536 in steps of one)

Maximum Output Frequency per channel *F* (available from 60 kHz to 3500 kHz)

Max-Movement-Speed *Vmax*

Interpolation = $Rf / 4$

$$R = P / Rf$$

Resolution [dpi] *Rdpi*

$$Rdpi = 25400 / R$$

Vmax is limited by following formulars:

1. $Vmax = 4 * F * R$
2. $Vmax = P * 50 \text{ kHz}$

LED Error Codes (Order Parameter E1)

The amount of flashing signs of the red LED indicates the fault. It starts after a fast pulsed light.



The example displays a weak and fluctuating magnetic field (fault 2 and 3).

LED flashing signs amount	Description
1	Magnetic field is too high
2	Magnetic field is too low
3	The range of the magnetic fluctuation is too large
4	Output frequency is too high
5	Movement speed is too high
6	Movement speed is much too high (latched)
7, 8	Movement speed too high for internal signal processing with current programming (latched)
9, 10, 11	Internal Error 9, 10, 11 (latched)

Dimensions

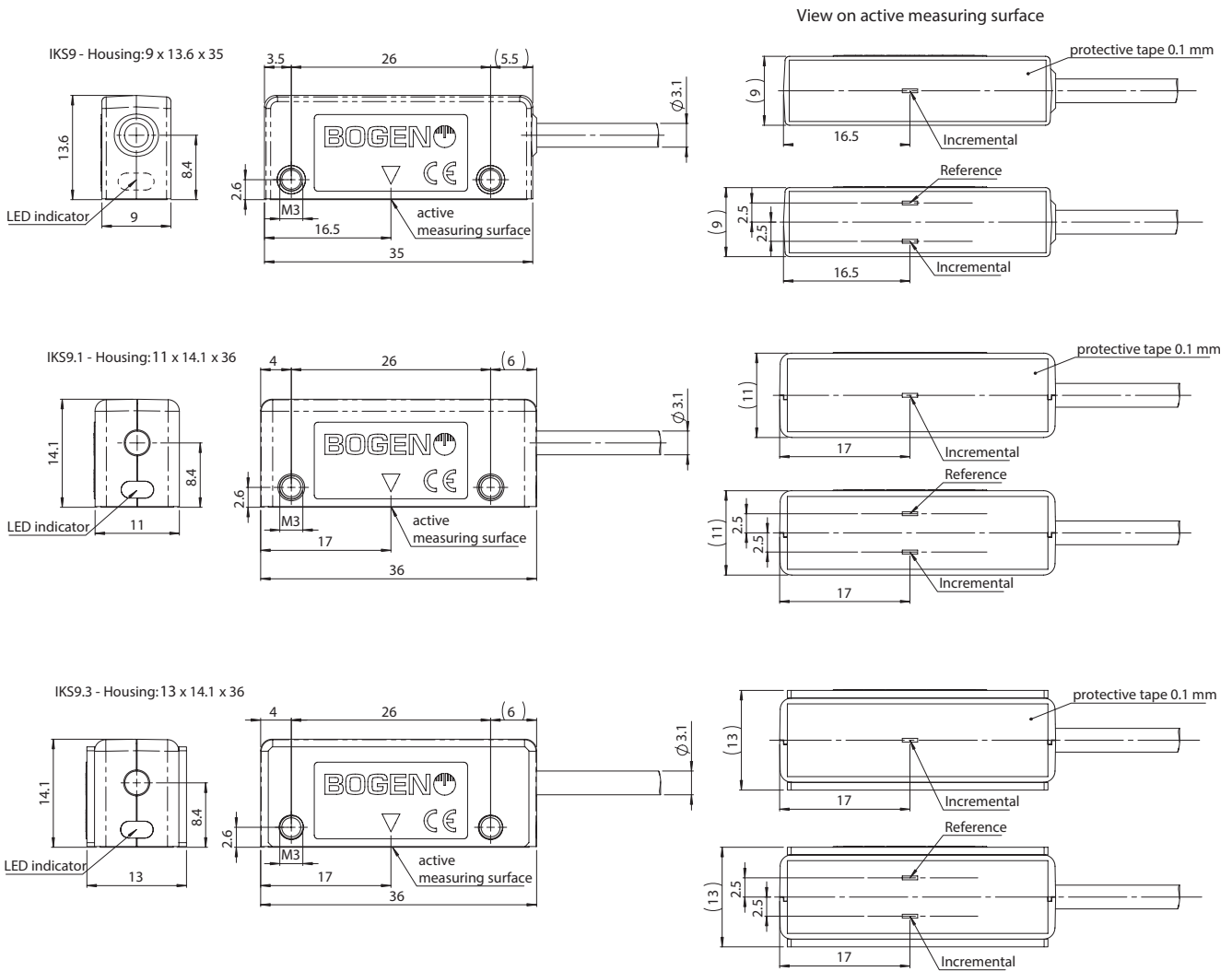

Installation Tolerances

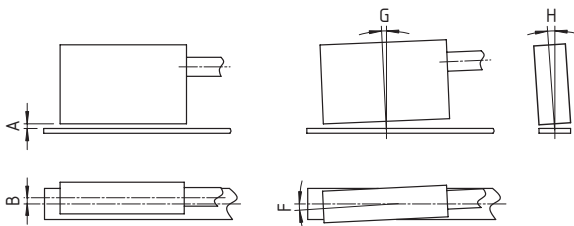

	Pole Pitch 0.5 mm	Pole Pitch 1 mm	Pole Pitch 2 mm	Pole Pitch 2.54 mm	Pole Pitch 5 mm
A [mm]	0.1 to 0.25	0.1 to 0.5	0.1 to 1.0	0.1 to 1.25	0.1 to 2.5
B ⁽⁴⁾ [mm]	2.5	2.5	2.5	2.5	2.5
B ⁽⁵⁾ [mm]	0.5	0.5	0.5	0.5	0.5
G	0.5°	1°	1°	1°	1°
H	3°	3°	3°	3°	3°
F	3°	3°	3°	3°	3°

⁽⁴⁾ relative to 10 mm scale width (1-track)

⁽⁵⁾ relative to 10 mm scale width (2-track)

Pin Assignment

Signal	Color	Pin No.				
		C2 M12 plug (male)	C3 D-SUB 9 (male)	C4 D-SUB 15 (male)	C5 D-SUB 25 (female)	C6 D-SUB 15 HD (male)
V -	blue	1	9	2	2 + 16 ⁽⁶⁾	2
V +	red	2	5	7	1 + 14 ⁽⁶⁾	7
A	brown	3	4	14	3	14
/A	green	4	8	6	4	6
B	grey	5	3	13	6	13
/B	yellow	6	7	5	7	5
Z	pink	7	2	12	17	12
/Z	white	8	6	4	18	4
Shield	-	1	Case	Case	Case	Case + 15

⁽⁶⁾ PIN 1 with Pin 14 and Pin 2 with Pin 16 connected through solder bridge

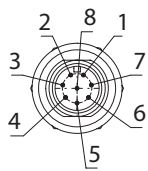

C2: M12 plug (male)

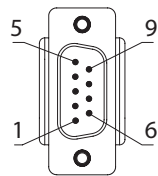

C3: D-SUB 9 (male)

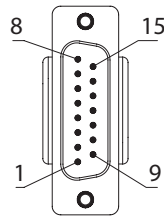

C4: D-SUB 15 (male)

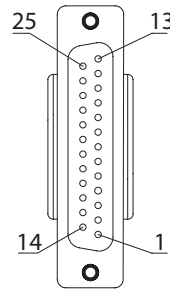

C5: D-SUB 25 (female)

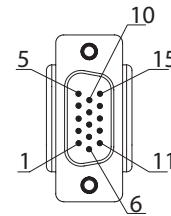

C6: D-SUB 15 HD (male)

Optional Accessory – Exemplary Linear Scales ⁽⁷⁾

Order Code	Pole Pitch	Accuracy Class	Width	Length [mm]	Index
	0.5	A3			Yes
	1	A10			No
	2	A20			
	2.54	A40			
	5	A100			

⁽⁷⁾ For ordering please take a look at the >data sheet for linear scales or contact our application engineers.

Optional Accessory – Exemplary Rotary Scales

See separate data sheet for rotary scales for further possibilities.

Optional Accessory - Linear Scales ⁽¹⁾

		Options ⁽²⁾
Parameters	Tracks	up to nine tracks, with or without reference
	Pole Pitch ⁽³⁾	0.5 mm
		1 mm
		2 mm
		2.54 mm
		5 mm
	Length	variable, up to 2300 mm
	Width (mm)	5 mm
		8 mm
		8 mm Elastomer (only for P95-05 extrusion)
		10 mm stainless steel carrier tape (only for P95-05 extrusion)
		10 mm
		12 mm
		15 mm
		20 mm
	Scale Height (mm)	1 mm magnetic tape, 0.3 mm carrier tape
1 mm magnetic tape, 0.1 mm carrier tape		
0.5 mm magnetic tape, 0.3 mm carrier tape		
0.5 mm magnetic tape, 0.1 mm carrier tape		
Accuracy Class	A3 ($\pm 3 \mu\text{m/m}$, only delivered up to piece length 2300 mm)	
	A10 ($\pm 10 \mu\text{m/m}$, only delivered up to piece length 2300 mm)	
	A20 ($\pm 20 \mu\text{m/m}$)	
	A40 ($\pm 40 \mu\text{m/m}$)	
	A100 ($\pm 100 \mu\text{m/m}$)	
Cover Tape	without cover tape	
	equipped with cover tape (only delivered up to piece length 1500 mm)	
Adhesive Tape	without adhesive tape	
	equipped with adhesive tape	
Text Imprint	with BOGEN text imprint	
	without text imprint	
	with customer specific text imprint	
Mounting Holes	without mounting holes	
	several standard options for mounting holes available, customization possible	

⁽¹⁾ for ordering please take a look at the >data sheet for linear scales or contact our application engineers

⁽²⁾ standard parameters are bold

⁽³⁾ only standard pole pitches listed

Order Code

Parameters

 IKS9 W - Z P V D R F T L C E

		Code ⁽⁸⁾	Explanation ⁽⁸⁾
W	Width [mm]		9 mm (Plastic case)
		.1	11 mm (Metal case)
		.3	13 mm (Metal case)
Z	Reference Signal ^(9,10)	Z1.50	Periodic index signal from the pole pitch, length of index signal 50 counts
		Z1. ...	Periodic index signal from the pole pitch, length of index signal ... counts ⁽¹¹⁾
		Z2. ...	From reference marks (requires 2-track magnetic tape with incremental track and reference track), length of index signal ... counts ⁽¹¹⁾
P	Pole Pitch [mm]	P0.5	0.5 mm (not interoperable with Z2)
		P1	1 mm
		P2	2 mm
		P2.54	2.54 mm
		P5	5 mm
V	Supply Voltage [V]	V5	5 V
		V24	7...32 V
D	Interface ⁽⁹⁾	D1	RS422
		D2	Push-Pull HTL
		D3	Push-Pull TTL
R	Resolution ^(9,*1)	R0.25	0.25 µm (Standard for pole pitch 0.5 mm)
		R0.5	Standard for pole pitch 1 mm
		R1	Standard for pole pitch 2 mm
		R#...	...dpi (Standard for pole pitch 2.54 mm)
		R2.5	Standard for pole pitch 5 mm
		R...	Other non-standard resolutions, see section "Resolution and Speed" in table 1 on page 2
F	Maximum Output Frequency per channel ⁽⁹⁾ [kHz]	F1000	1000 kHz
		F...	Other non-standard output frequencies, see section "Resolution and Speed" in table 1 on page 2
T	Cable Type	T2	Drag chain quality (4 mm diameter)
		T99	Customer specific cable
L	Cable Length [m]	L1	1 m
		L2	2 m
		L3	3 m
		L...	... m
C	Connector (others on request)	C2	M12 plug (male)
		C3	D-SUB 9 (male)
		C4	D-SUB 15 (male)
		C5	D-SUB 25 (female)
		C6	D-SUB 15 HD (male)
		C99	Customer specific connector
E	LED Mode ⁽⁹⁾	E0	LED Green: Low -> sufficient magnetic field Bright -> best performance LED RED: Error signalization with LED on
		E1	LED Green: Low -> sufficient magnetic field Bright -> best performance LED RED: Error signalization with blinking codes, see on page 3

⁽⁸⁾ standard parameters are bold

⁽⁹⁾ user programmable parameters (optional IKS-Programming device necessary)

⁽¹⁰⁾ if no index signal is needed, please do not connect pin "Z" an "/Z" on delivered connector

⁽¹¹⁾ length of index signal available from 1 to 256

^(*) R... for metric based pole pitches / R#... for inch based pole pitches

Ordering Example

IKS9-Z1.50P2V5D1R1F1000T2L2C4E1 IKS9 Magnetic Sensing Head, width 9 mm, with periodic index signal, index length 50 counts, 2 mm pole pitch, voltage 5 V, interface RS422, 1 μ m resolution, max. output frequency 1000 kHz, Drag chain quality (4 mm diameter), cable length 2 m, D-SUB 15 (male) connector, error signalization with blinking error codes

IKS9.1-Z2.1P5V24D3R125F100T2L5.5C5E0 IKS9 Magnetic Sensing Head, width 11 mm, with reference signal from reference marks (2-track magnetic tape), index length 1 count, 5 mm pole pitch, voltage 7-32 V (broad-range), interface Push-Pull TTL, 125 μ m resolution, max. output frequency 100 kHz, Drag chain quality (4 mm diameter), cable length 5.5 m, D-SUB 25 (female) connector, error signalization with LED RED on

BOGEN can provide customised resolutions and cables. Here is an ordering example for a customized order code:

IKS9.1-Z2.50P2V5D1R0.244140625F3500T99L0.3C4E1 IKS9 Magnetic Sensing Head, width 11 mm, with reference signal from reference marks (2-track magnetic tape), index length 50 count, 2 mm pole pitch, voltage 5 V, interface RS422, 0.244140625 μ m resolution, max. output frequency 3500 kHz, customer specific cable, cable length 0.3 m, D-SUB 15 (male) connector, error signalization with blinking error codes

IKS9.3-Z1.1P2V5D1R15.625F2333T99L0.6C6E1 IKS9 Magnetic Sensing Head, width 13 mm, with periodic index signal, index length 1 count, 2 mm pole pitch, voltage 5 V, interface RS422, 15.625 μ m resolution, max. output frequency 2333 kHz, customer specific cable, cable length 0.6 m, D-SUB 15 HD (male) connector, error signalization with blinking error codes